

SONY



Look for the Angry Birds movie in 4K Ultra HD



Model shown is VPL-VW260ES

At a glance

- 4K resolution: 4096 x 2160
- 1,500 ANSI lumens (VPL-VW260ES/360ES)
- 1,800 ANSI lumens (VPL-VW550ES)
- Advanced SXR technology
- Very high contrast, ideal for HDR
- Futureproofed with support for latest picture standards

VPL-VW260ES/ VW360ES/VW550ES

Experience Home Cinema in true 4K HDR



Seeing is believing

Experience the beauty of true 4K

Bring incredible 4K detail to your favourite movies

Imagine bringing the truly cinematic quality of 4K into your own home. Now you can make this a reality with our VPL-VW550ES/VW360ES/VW260ES series of Home Cinema projectors. They produce true 4K resolution images with our native 4K (4096 x 2160) SXRD panels - that's over four times the quality of Full HD.

Designed for your home cinema room and living room, the VPL-VW550ES/VW360ES/VW260ES deliver stunning, detail-packed images and incredibly lifelike colour like never before. And with high brightness, you're guaranteed an exceptional picture even in well-lit rooms.



This image is VPL-VW550ES/VW360ES.

Breathtaking Picture Quality

Native 4K SXRDTM panel

Advanced Sony's SXRDTM (Silicon X-tal Reflective Display) panel technology featured in Sony's digital cinema projectors delivers native 4K (4096 x 2160) resolution images, with more than four times the detail of Full HD. Fine details are wonderfully clear and natural, without jagged edges or visible pixels.

Native 4K Panel



4096 x 2160 (8.8 million pixels)



See deeper blacks with 4K SXRDTM panels

Latest SXRDTM panels deliver even better contrast, as well as native 4K resolution. SXRDTM projection offers rich, inky blacks, as well as clear cinematic motion and image smoothness. Improvements to the silicon layer now mean even better light control, for precisely delivered shadows and blacks

Conventional SXRDTM

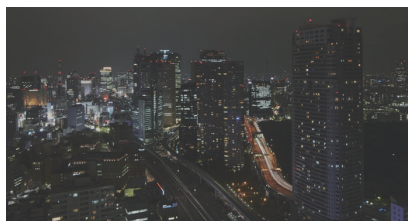
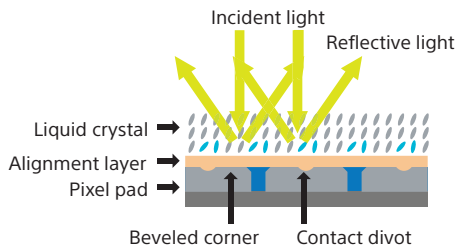

Simulated images

Latest SXRDTM

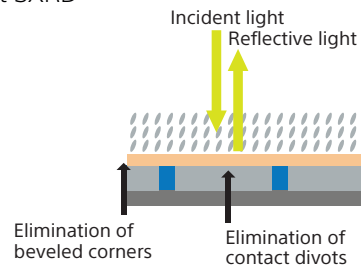

Higher contrast

Sony's 4K Projection

With more than four times the resolution of Full HD, native 4K offers 8.8 million pixels (4096 x 2160) for a picture that's incredibly lifelike, which is why it is the resolution defined by the DCI (Digital Cinema Initiative) for cinema distribution. See corner-to-corner clarity and watch movies from much closer than you would in Full HD.

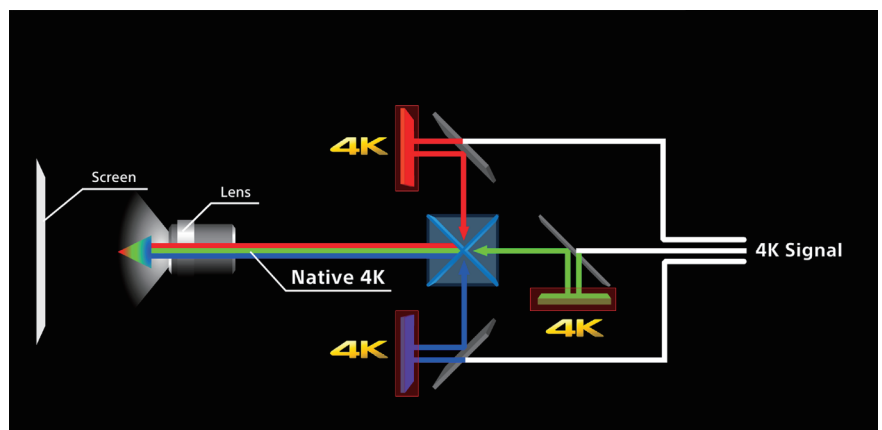

Bright Feel

Sony's SXR panel can achieve the highest contrast ratio compare to other devices. As a result of high contrast, it gives you the feel of high brightness, and thus more immersiveness.



Standard Home Cinema Projector



Sony Home Cinema Projector

Simulated images

Remarkable Dynamic Contrast for Highest Picture Quality

With Sony's Advanced Iris3 technology, this projector can achieve an incredible dynamic contrast for the best ever images

* The VPL-VW550ES/VW360ES.

HDR Compatible

Get the most from your projector when viewing new UHD Blu-ray and streaming services with High Dynamic Range (HDR). HDR video offers a vastly expanded brightness range to deliver far more realistic, high-contrast images and brilliant colours. Compatible with both HDR10 and HLG (Hybrid Log-Gamma) formats. Sony's home projectors reproduce colour and contrast faithfully to creators' intentions.



SDR*

* Standard Dynamic Range



HDR

Simulated images

The super-resolution Reality Creation

Sony's exclusive Reality Creation technology analyzes images right down to the pixel level. It then employs pattern-matching algorithms developed over years of movie production to enhance crispness even without increasing digital picture noise. It also upscales existing full HD Blu-ray Disc™ and DVD movies to near 4K quality.

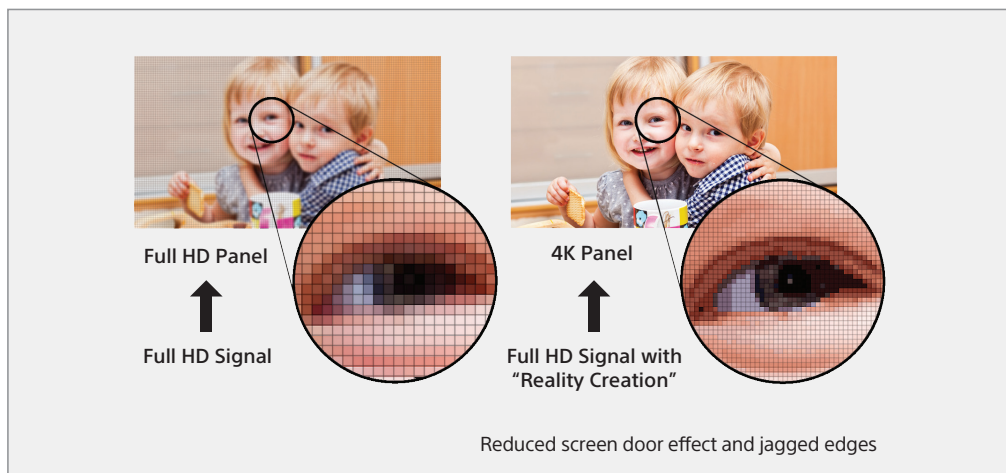

Simulated images

TRILUMINOS™ Display

Discover true-to life colours and tones. The projector's incorporates TRILUMINOS colour, reproducing more tones and textures than a standard projector system. Hard-to-reproduce crimson reds, aqua blues, and emerald greens are displayed beautifully, so landscapes and seascapes look more vivid. Faces look better, too, with skin tones more faithfully reproduced.



Simulated images

Advanced Motionflow™

Whatever you're watching, you'll enjoy a silky smooth on-screen look in fast-moving action sequences with Motionflow. This innovative technology creates and inserts extra frames between the original frames, first comparing key visual factors on successive frames, then calculating the split second of missing action in the sequences. True Cinema 24p mode mimics true movie projection for cinema purists.

Without Motionflow



With Motionflow



Simulated images

Installation Advantages

Compact and Functional Design

Achieving such compact size, provides great flexibility for a variety of installation situations.

Wider Zoom and Shift Lens

The projector offers a powered lens for zoom, shift and focus operations to provide maximum flexibility for home installations, including high ceiling mounting.

Front-facing Fan

Because the fan is positioned at the front, you don't need to leave a large gap between the back of the projector and the wall for air intake not inhale exhaust when you install. This helps maximize the throw distance for bigger projected images.

Picture Position Memory Matches Movie Aspect Ratio

The projector has a set of memory registers to store the position of the lens (focus, zoom, shift). Users can match a movie's aspect ratio, including 1.78:1 and 2.35:1, and store these settings in the projector for easy recall.

* The VPL-VW550ES/VW360ES.

Screen 2.35:1



Position 1.78:1 Image 1.78:1

Screen 2.35:1



Position 1.78:1 Image 2.35:1

2.35:1 without picture position memory

Screen 2.35:1



Position 2.35:1 Image 2.35:1

2.35:1 with picture position memory

Simulated images

Electronic Panel Alignment

Ensures the red and blue elements in each pixel are precisely positioned against green. Adjustments can be made by as little as 0.1 pixels for optimum clarity.

User-friendly Functions

Built-in Auto Calibration

After extended periods, colour can be automatically calibrated to the original factory condition. There's no need for extra calibration equipment or cameras; a built-in colour sensor stores all the necessary information.

* The VPL-VW550ES/360ES.

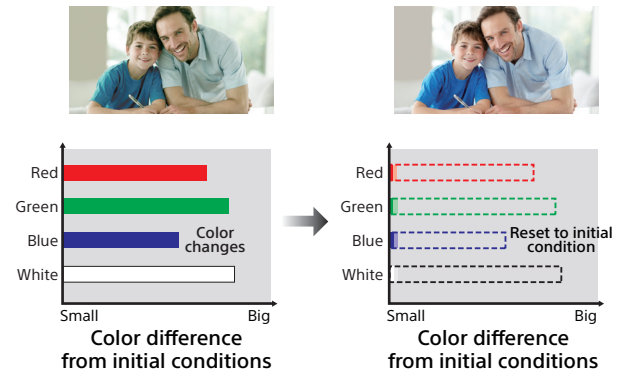

HDCP 2.2 Compatibility

Both HDMI inputs are compatible with HDCP 2.2 - the latest content protection standard.

Industry-standard RF 3D Compatible

A built-in RF transmitter synchronizes with most RF 3D glasses for wider coverage and greater stability, and there's no need for an external transmitter.

Long-lasting Lamp

By incorporating a high-performance lamp and advanced lamp-control technology, the projectors deliver an extremely long lamp replacement time of 6,000 hours*.

* Approximate recommended period, in low mode.

Low Latency Mode

A new feature for gamers. Experience our fastest ever response time between your controller and the screen for ultimate gaming action.

Easy Connectivity for Home Automation

Compatible with many home automation systems via an RJ45(IP), RS-232C, TRIGGER and IR IN interfaces.

Low fan noise 26dB*

Whisper-quiet fan noise minimises disturbance for your audience.

* They will depend on the environment or how the projectors is used. When under normal environment.

Dimensions

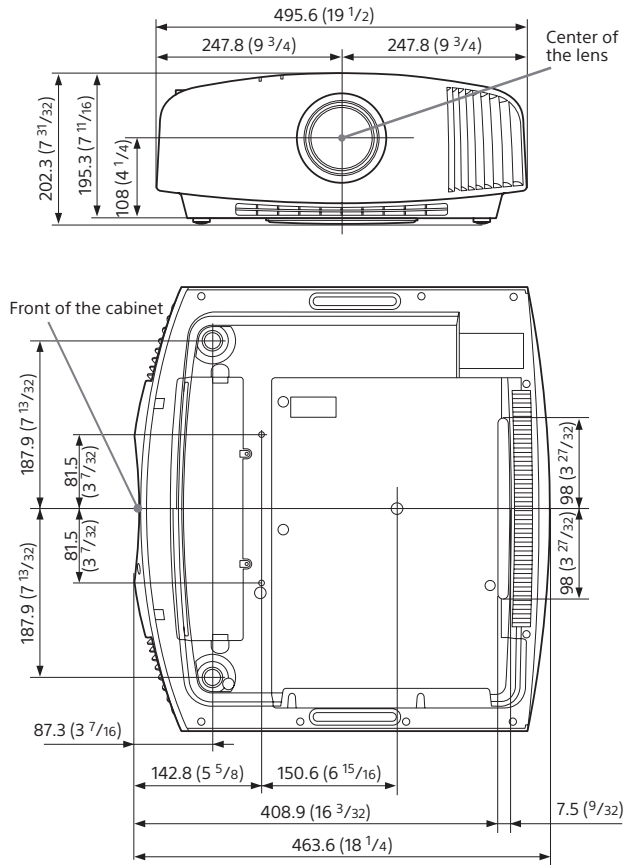

Units: mm (inches)

Connector Panel

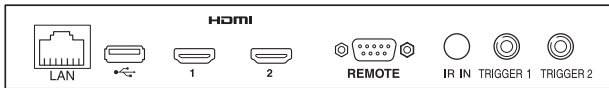

Optional Accessories



LMP-H280 for VPL-VW550ES
Projector Lamp (for replacement)



LMP-H220 for VPL-VW360ES
/VW260ES
Projector Lamp (for replacement)



TDG-BT500A
3D Glasses

Projection distance

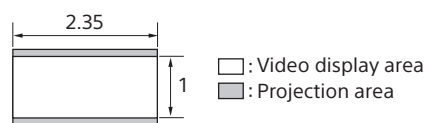
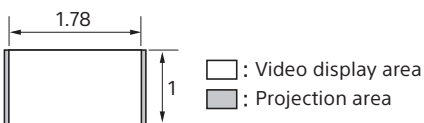

1.78:1 (16:9)		
Projection image size		Projection distance L
Diagonal	Width × Height	
80" (2.03 m)	1.77 × 1.00 (70 × 39)	2.44 – 5.01 (96 – 197)
100" (2.54 m)	2.21 × 1.25 (87 × 49)	3.05 – 6.28 (121 – 247)
120" (3.05 m)	2.66 × 1.49 (105 × 59)	3.67 – 7.55 (145 – 297)
150" (3.81 m)	3.32 × 1.87 (131 × 74)	4.60 – 9.44 (181 – 371)
200" (5.08 m)	4.43 × 2.49 (174 × 98)	6.15 – 12.61 (242 – 496)

2.35:1		
Projection image size		Projection distance L
Diagonal	Width × Height	
80" (2.03 m)	1.87 × 0.80 (74 × 31)	2.41 – 4.96 (95 – 195)
100" (2.54 m)	2.34 × 0.99 (92 × 39)	3.02 – 6.22 (119 – 244)
120" (3.05 m)	2.80 × 1.19 (110 × 47)	3.64 – 7.47 (143 – 294)
150" (3.81 m)	3.51 × 1.49 (138 × 59)	4.55 – 9.35 (180 – 368)
200" (5.08 m)	4.67 × 1.99 (184 × 78)	6.08 – 12.48 (240 – 491)

Specifications

		VPL-VW550ES	VPL-VW360ES	VPL-VW260ES
Display System		4K SXRD panel, projection system		
Display device	Size of effective display area	0.74" x 3		
	Number of pixels	26,542,080 (4096 x 2160 x 3) pixels		
Projection lens	Focus	Powered		
	Zoom	Powered (Approx. x 2.06)		
	Lens shift	Powered Vertical: +85% -80% Horizontal: +/-31%		
Light source		High-pressure mercury lamp, 280 W type	High-pressure mercury lamp, 225 W type	
Recommended lamp replacement time*1		6000 H (Lamp mode:Low)		
Screen size		60" to 300" (1,524 mm to 7,620 mm)		
Light output		1800 lm (Lamp mode: High)*2	1500 lm (Lamp mode: High)*2	
Colour light output		1800 lm (Lamp mode: High)*2	1500 lm (Lamp mode: High)*2	
Dynamic contrast		350,000:1	200,000:1	-
Displayable scanning frequency	Horizontal	19 kHz to 72 kHz		
	Vertical	48 Hz to 92 Hz		
Display resolution*3	Computer signal input	Maximum display resolution: 1920 x 1080 dots (HDMI Input only)		
	Video signal input	480/60p, 576/50p, 720/60p, 720/50p, 1080/60i, 1080/50i, 1080/60p, 1080/50p, 1080/24p, 3840 x 2160/24p, 3840 x 2160/25p, 3840 x 2160/30p, 3840 x 2160/50p*4, 3840 x 2160/60p*4, 4096 x 2160/24p, 4096 x 2160/25p, 4096 x 2160/30p, 4096 x 2160/50p*4, 4096 x 2160/60p*4		
OSD language		18-languages (English, Dutch, French, Italian, German, Spanish, Portuguese, Turkish, Polish, Russian, Swedish, Norwegian, Japanese, Simplified Chinese, Traditional Chinese, Korean, Thai, Arabic)		
INPUT	HDMI1 / HDMI2*5	Digital (RGB/Y Pb/Cb Pr/Cr)		
OUTPUT (Computer / Video / Control)	Trigger1 / Trigger2	Minijack, DC 12 V Max. 100 mA		
	Remote	RS-232C, D-sub 9-pin (female)		
	LAN	RJ45, 10Base-T/100BASE-TX		
	IR IN	Mini Jack		
	USB	DC 5V, Max. 500 mA		
Acoustic noise		26 dB		
Operating temperature / Operating humidity		5°C to 35°C (41°F to 95°F) / 35% to 85% (no condensation)		
Storage temperature / Storage humidity		-20°C to +60°C (-4°F to +140°F) / 10% to 90% (no condensation)		
Power requirements		AC 100 V to 240 V, 4.1 A to 1.7 A, 50/60Hz	AC 100 V to 240 V, 3.5A to 1.5A, 50/60Hz	
Power consumption		410 W		
	Standby	0.3 W (when "Remote Start" is set to "Off")		
	Networked Standby	1.0 W (LAN) (when "Remote Start" is set to "On") When a LAN terminal is not connected, it becomes a low power consumption mode (0.5 W).		
Dimensions (W x H x D) (without protrusions)		495.6 x 195.3 x 463.6 mm 19 1/2 x 7 11/16 x 18 1/4 inches		
Mass		Approx. 14 kg / 31 lb		
Supplied accessories		RM-PJ24 Remote Commander (1), Size AA (R6) Manganese Batteries (2), Lens Cap (1), AC Power Cord (1), Operating Instructions (CD-ROM) (1), Quick Reference Manual (1)		
Replacement lamp		LMP-H280	LMP-H220	

*1 The figures are expected maintenance time and not guaranteed. They will depend on the environment or how the projector is used.

*2 The values are estimate.

*3 Displayed image may be converted for some input signals.

*4 YCbCr 4:2:0. And the displayed format is in 8bit

*5 Both HDMI inputs are compatible with HDCP2.2

PrimeSupport
Pro

Distributed by

©2017 Sony Corporation. All rights reserved. Reproduction in whole or in part without written permission is prohibited. Features and specifications are subject to change without notice. The values for mass and dimension are approximate. "SONY", "BrightEra" and "Remote Commander" are trademarks of Sony Corporation. The terms HDMI and HDMI High-Definition Multimedia Interface, and the HDMI Logo are trademarks or registered trademarks of HDMI Licensing LLC in the United States and other countries. All other trademarks are the property of their respective owners. Please visit Sony's professional website or contact your Sony representative for specific models available in your region.

For full product specifications and features please visit pro.sony.eu/homecinemaprojectors

SONY